



MTX-OL PLUS USER MANUAL



Warning!

The Oxygen Sensor used in this device gets very hot in operation. Do not touch a hot sensor. Do not let a hot sensor touch a combustible surface. Do not use the sensor with or near flammable liquids or gases. Failure to heed these warnings may result in severe burns, explosions, fires, or other dangerous events.

1.	MTX-OL PLUS	2
	1.1 Changing the MTX-OL PLUS gauge face and/or bezel.....	3
2	Installation	4
	2.1 Wiring	4
	2.1.1 Relay Wiring Instructions.....	5
	2.2 MTX-OL PLUS Mounting and Routing	5
	2.3 Oxygen Sensor Placement	6
	2.4 Sensor Calibration.....	8
	2.4.1 Calibration Schedule	8
3.	MTX-OL PLUS Configuration	9
	3.1 Configuration using the LM Programmer software	9
	3.2 Display Settings (Gauge Abbreviations).....	9
4.	Logworks 3 & LM Programmer Software Package.....	10
	4.1 Download and Install the Logworks 3 Software	10
	4.2 LM Programmer	10
	4.2.1 Programming Analog Output	10
	4.2.2 Advanced Analog Output Programming	11
	4.2.3 Updating the Firmware	11
	4.2.4 Changing Sensor Type	12
	4.3 Logging data from your MTX-OL PLUS with LogWorks	12
	4.3.1 Adding and Logging MTS channels.....	13
	Appendix A: Limited Warranty	14
	Appendix B: MTX-OL PLUS Error Codes and Troubleshooting Tips....	15
	Contact Information	16



Innovate Motorsports

413 West Elm Street

Sycamore, IL 60178

TEL: (800) 348-3037

International: (815) 991-2136

Email: sales@innovatemotorsports.com

www.innovatemotorsports.com

1. MTX-OL PLUS

The MTX-OL PLUS is an integrated gauge and controller for wideband AFR (lambda) measurements. Although it can be operated stand alone, it has digital I/O for integration with other Innovate MTS compatible products and a configurable analog output for integration with ECU's and 3rd party data loggers. The following will help you get familiar with the unit.

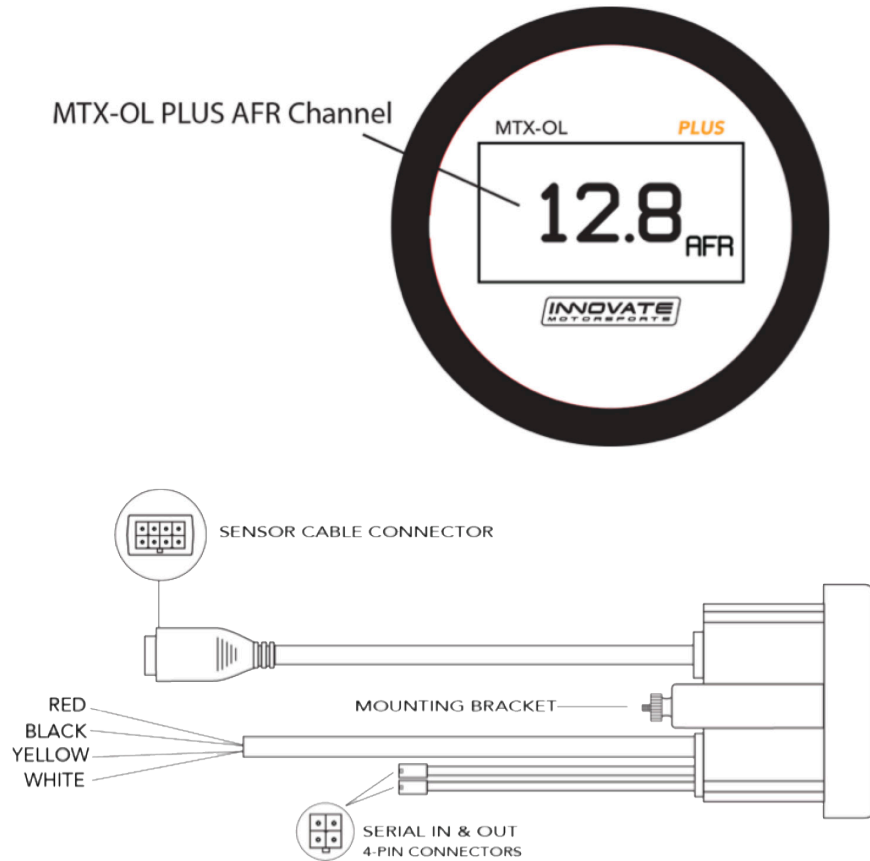

Kit Includes
MTX-OL Plus Gauge Assembly
Universal Mounting Hardware
LSU 4.9 Sensor
LSU 4.9 Sensor Cable (3ft or 8ft)
Weld-in O2 Bung M18x1.5
Serial Programming Cable

Appendix B: MTX-OL PLUS Error Codes and Troubleshooting Tips

Error Code	Error Message	Likely Root Cause	Fix
Error 1	Heater circuit shorted	Short in sensor	Replace sensor.
Error 2	Heater circuit open	1. Damaged sensor cable or sensor. 2. Sensor connector not fully seated and locked into position.	1. Verify that all sensor connectors are fully seated and locked into position. 2. Replace sensor 3. Replace sensor cable.
Error 3	Pump cell circuit shorted	1. Short in sensor cable 2. Short in sensor 3. Sensor calibration incorrect	1. Perform sensor recalibration. 2. Replace sensor cable. 3. Replace sensor.
Error 4	Pump cell circuit open	1. Damaged sensor cable or sensor. 2. Connectors not fully seated 3. Sensor calibration incorrect	1. Verify that all sensor connectors are fully seated and locked into position 2. Perform sensor calibration 3. Replace sensor cable 4. Replace sensor.
Error 5	Reference cell circuit shorted	1. Short in sensor cable 2. Short in sensor	1. Replace sensor cable. 2. Replace sensor.
Error 6	Reference cell circuit open	1. Damaged sensor cable or sensor. 2. Connectors not fully seated	1. Verify that all sensor connectors are fully seated and locked into position. 2. Replace sensor. 3. Replace sensor cable.
Error 7	System error	System error	Reboot MTX-OL PLUS by cycling power.
Error 8	Sensor Timing error (typically a damaged sensor).	1. Sensor over-heating or over-cooling (error condition only occurs at wide open throttle) 2. Sensor is damaged	1. Perform sensor calibration. 2. Move sensor bung as far downstream as possible. 3. Add an HBX-1 (p/n 37290) to isolate the sensor from the pipe. 4. Replace sensor.
Error 9	Supply Voltage too low	Supply voltage too low for sensor regulation	1. Verify you have 12V at your power source and the circuit can support a 3 amp draw.

NOTE: If gauge is giving off erratic readings do a free air calibration (2.4) page 8.

Appendix A: Limited Warranty

LIMITED WARRANTY

Innovate stands behind the quality of its products. Innovate makes the following warranty to purchasers of its products: All new Innovate products carry a one year warranty from the date of purchase. If proof of purchase cannot be provided, warranty will be determined by date of manufacture.

When Warranty Void

This warranty shall terminate and Innovate shall have no obligation pursuant to it if (i) your Innovate product has been modified or repaired in a manner not previously authorized by Innovate in writing, (ii) the identification markings on your Innovate product have been removed, defaced, or altered; (iii) your Innovate product was subjected to accident, abuse, shipping damage, or improper use; (iv) your Innovate product was not used or configured as specified in the product manual; or (v) your Innovate product was subjected to operating conditions more severe than those specified in the product manual.

Exclusions From This Warranty

Oxygen Sensors are excluded from this warranty.

Repairs Under This Warranty

In the unlikely event that your Innovate hardware product should prove defective during the warranty period, contact Innovate Customer Support at http://www.innovatemotorsports.com/rma_form.php for a return material authorization (RMA). Products returned for service must be securely packed to prevent damage and shipped charges pre paid, along with proof of purchase and the return material authorization number, to the Innovate repair location as instructed by Customer Service. Innovate within a reasonable amount of time from its receipt of your product so shipped, will ship to you, at its option, the repaired product or a new or reconditioned product of comparable or greater specified functionality. All repaired or replacement products shall be warranted for the remainder of the original product warranty.

Disclaimer

INNOVATE MAKES NO OTHER EXPRESS OR IMPLIED WARRANTY WITH RESPECT TO YOUR INNOVATE PRODUCT OTHER THAN THE LIMITED WARRANTY SET FORTH ABOVE. No Innovate dealer, agent, or employee is authorized to make any modification, extension, or addition to this warranty, unless enforceable or unlawful under applicable law, INNOVATE DISCLAIMS ALL IMPLIED WARRANTIES, INCLUDING THE IMPLIED WARRANTIES OF MERCHANTABILITY, NON INFRINGEMENT, AND FITNESS FOR A PARTICULAR PURPOSE, AND THE LIABILITY OF INNOVATE, IF ANY, FOR DAMAGES RELATING TO ANY ALLEGEDLY DEFECTIVE PRODUCT SHALL UNDER ANY TORT, CONTRACT, OR OTHER LEGAL THEORY BE LIMITED TO THE ACTUAL PRICE PAID FOR SUCH PRODUCT AND SHALL IN NO EVENT INCLUDE INCIDENTAL, CONSEQUENTIAL, SPECIAL, OR INDIRECT DAMAGES OF ANY KIND EVEN IF INNOVATE IS AWARE OF THE POSSIBILITY OF SUCH DAMAGES. Some states do not allow limitations on how long an implied warranty lasts or the exclusion or limitation of incidental or consequential damages, so the above limitations or exclusions may not apply to you.

1.1 Changing the MTX-OL PLUS gauge face and/or bezel

1. Lay the MTX-OL PLUS face down and remove the three #2 phillips screws from the outside rim of the back plate.

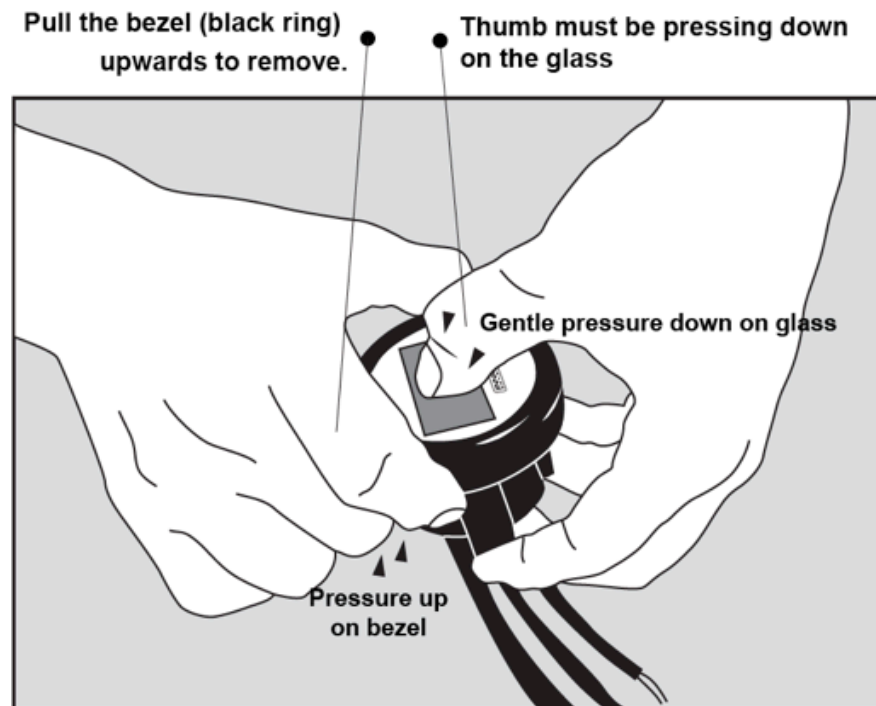

⚠ Pulling bezel upwards while NOT holding the glass down can ⚠ potentially damage the gauge.

NOTE: When replacing the bezel and/or gauge face verify that the o-ring is properly seated.

2. Configure the gauge as desired by changing the gauge face and/or bezel.
3. Make sure every piece is positioned correctly using the locating tab and reassemble the gauge.
4. Reinstall the three #2 phillips screws verifying that the buttons are not binding on the gauge lens.

2 Installation

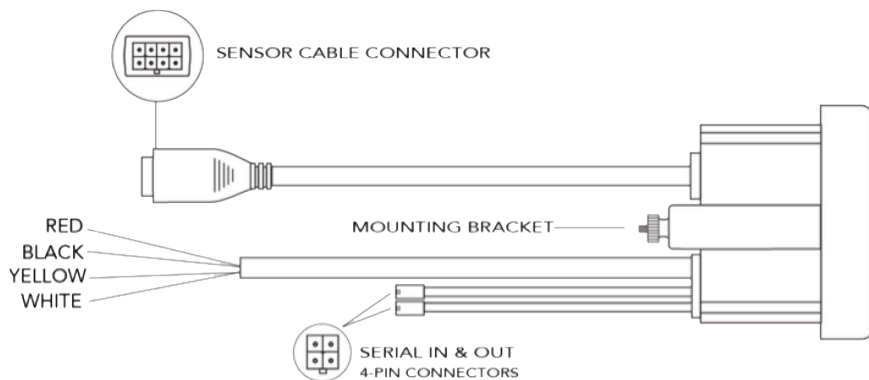

2.1 Wiring

The MTX-OL PLUS has 4 stripped wire ends:

- 1 Connect the **RED** wire to an isolated switched 12V source in your vehicle. A switched 12V source goes ON as soon as “key on” power is active. The circuit to which you will pull power from should be able to support a 3 amp draw. Make sure this connection is protected with a 5A fuse.

⚠ Circuits that share power with the vehicle’s stereo, ignition system, ECU, lighting, or fuel pump should not be used. When in doubt, create an additional circuit using an automotive relay available at any automotive parts supplier. See section 2.1.1 for a relay installation diagram.

- 2 The **BLACK** wire should be grounded to a solid ground source. The best ground source for instruments is the engine block.

⚠ If other Innovate Motorsports devices are going to be daisy-chained along with the MTX-OL PLUS, it is recommended that all devices be connected to a single ground point, ideally the engine block.

- 3 Connect the **WHITE** wire to a headlight power wire (a wire that supplies current to the headlights). This enables the display to dim for better nighttime viewing. **DO NOT CONNECT THIS WIRE TO THE HEADLIGHT (Dash lights) DIMMING WIRE.** Connection to this rheostat type of switch will cause the gauge to malfunction. If you chose not to utilize the dimming feature, connect the WHITE wire to ground.

4.3.1 Adding and Logging MTS channels

The Innovate Motorsports’ MTS (Modular Tuning System) allows you to daisy chain multiple devices together via the serial IN and OUT connectors to form one single synchronous log. MTS log chains can consist of a single unit connected directly to a laptop, or multiple devices connected together, up to 32 channels.

Lambda vs AFR

Lambda	Air Fuel Ratio				
	Gasoline	Methanol	E85 Blend	Diesel	LPG
0.07	10.3	4.5	6.8	10.2	10.9
0.75	11.0	4.8	7.3	10.9	11.6
0.80	11.8	5.1	7.8	11.6	12.4
0.85	12.5	5.4	8.3	12.3	13.2
0.90	13.2	5.8	8.8	13.1	14.0
1.00	14.7	6.4	9.8	14.5	15.5
1.05	15.4	6.7	10.3	15.2	16.3
1.10	16.2	7.0	10.8	16.0	17.1
1.15	16.9	7.4	11.2	16.7	17.8
1.20	17.6	7.7	11.7	17.4	18.6
1.25	18.4	8.0	12.2	18.1	19.4
1.30	19.1	8.3	12.7	18.9	20.2
1.35	19.8	8.6	13.2	19.6	20.9
1.40	20.6	9.0	13.7	20.3	21.7
1.45	21.3	9.3	14.2	21.0	22.5
1.50	22.1	9.6	14.7	21.8	23.3
1.55	22.8	9.9	15.1	22.5	24.0
1.60	23.5	10.2	15.6	23.2	24.8

4.2.4 Changing Sensor Type

The MTX-OL PLUS is multi sensor compatible with the Bosch LSU 4.2 and 4.9 sensors. In order to go from one sensor type to another the MTX-OL PLUS must be connected to the LM Programmer software and the appropriate sensor type must be selected. The “Sensor Type to use” setting can be found in the ‘Info’ tab when LM Programmer connects to the MTX-OL PLUS. Once the sensor type is changed a sensor calibration must be performed with the sensor outside of the exhaust (see Sensor Calibration chapter.)



Sensor Cable PN:	3ft.	8ft.	18ft.	Sensor PN:	
LSU4.2	38430	38100	38280	LSU4.2	37370
LSU4.9	38900	38870	38890	LSU4.9	38880

Note: All sensor cables for the LSU4.9 are easily identified by a ‘4.9’ marking molded on the sensor connector side.

! Use the appropriate sensor cable for the sensor type as each sensor has a different style connector. Spliced cable can not only affect the wideband controller’s performance but in worst cases it can damage the sensor and/or controller.

! Selecting the wrong sensor type to the sensor being used will not only give you erroneous readings and/or errors. It can also permanently damage the sensor.

4.3 Logging data from your MTX-OL PLUS with LogWorks

1. Connect the OUT port of the MTX-OL PLUS to the provided serial programming cable. Connect the other end of the serial programming cable to your computer. If your computer does not have a serial port, you can purchase a USB to Serial adapter from Innovate Motorsports (P/N 37330) or use any USB to serial adaptor that includes drivers. Power up the system.
2. Launch LogWorks. The LogWorks application can be launched from Start->Programs->LogWorks3->Logworks3 from the Windows task bar.
3. Once LogWorks launches go to File->Connect. You will be prompted to connect to the serial COM port. Select the comport the device is connected to and then click Connect.
4. To start recording go to File->New Realtime Log or, in the Toolbar, click on the  Tool.

- 4 (Optional), the **YELLOW** (Analog output) can be connected to the analog input of other devices such as data loggers or ECUs. If this output is not going to be used, insulate the wire out of the way. The default analog output is configured as follows: 0V = 7.35 AFR and 5V = 22.39 AFR. This can be changed in the LM Programmer software. See section 4.2.1.

It is assumed that the MTX-OL PLUS and the device the analog output is being fed to are already sharing the same ‘ground’. In a vehicle, this is generally true, but there can be small offsets in voltage when devices are grounded to, say, the chassis at different points. You can minimize these offsets by sharing a good, common ground point.

2.1.1 Relay Wiring Instructions

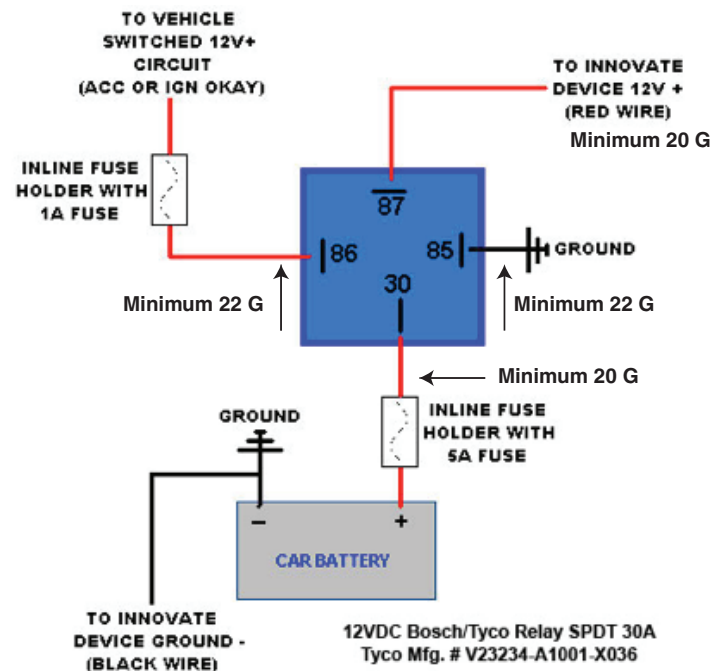

NOTE: Use of a relay is not required for installation but can be helpful in providing clean power, particularly if your vehicle has limited options for key switched power.

2.2 MTX-OL PLUS Mounting and Routing

The MTX-OL PLUS gauge fits in any standard 2 1/16” (52mm) gauge pod. Mounting of the gauge should be done in such a manner that the cables are not being forcefully pulled and strained from the gauge itself. Route the sensor cable avoiding contact with the exhaust pipe and other hot sources that could melt the cable. Also avoid routing the sensor cable near ignition components or other sources of RF (radio frequency) and EMI (Electromagnetic interference) noise.

The MTX-OL PLUS gauge is splash resistant (not water proof) and can be mounted so that it is exposed to the outdoor elements. The MTX-OL PLUS should not be submerged and special consideration should be taken to protect the gauge from direct water spray (water coming from a pressurized source.) When replacing the bezel and/or gauge face verify that the o-ring is properly seated.

2.3 Sensor Placement

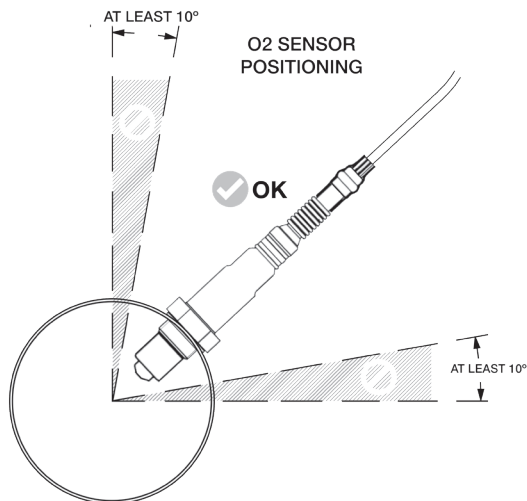

Tightening Torque - 33-44ft/lbs (45-60Nm)

Optimum bung placement will vary from application to application, but using the guideline below will ensure the longest sensor life with the most accurate readings. Using a bung is the preferred method for mounting the oxygen sensor in all applications.

The included Bosch LSU4.9 heated oxygen sensor comes with a 1 in. mild steel weld-in bung and wiring harness. The oxygen sensor should be installed on the exhaust manifold as close to the cylinder head as reasonably possible so that the sensor reaches operating temperature quickly while not exceeding the maximum hexagon temperature of 1,112°F (600°C) and maximum continuous exhaust gas exposure temperature of 1,706 °F (930° C). If these temperatures are exceeded install HBX-1 (p/n 37290). If long tube headers are used, the oxygen sensor should typically be installed in the collector, or applications where individual cylinder readings are not required. If cast iron manifold(s) or shorty headers are used, install the sensor in the pipe just below the manifold seeking an ideal distance of 18 in. (46 cm) from cylinder head exhaust port or turbo exhaust port. In multi-bank applications where a single sensor is being utilized, mounting in the left or right side is acceptable and should ideally place the sensor on the bank known to house the leanest cylinder. Open header applications will require a minimum length of 18-24 in. (46-61 cm) of exhaust pipe after sensor for proper reading at idle and part throttle.

Click the 'Program' button to upload your modified A/F or lambda scaling data into the MTX-OL PLUS. Once the unit has been programmed, the 'Program' button will grey out.

Factory Programmed Default:

The analog output by default is programmed to output between 0V at 7.35 AFR to 5.0V at 22.39 AFR.

4.2.2 Advanced Analog Output Programming

The 'Advanced' button allows the user to set the analog out update speed and the voltage output during sensor Warm-up and error conditions. The factory defaults of the analog outputs update 1/12 of a second. The default voltage output is set at 0 volts for both the Warm-up and error conditions.

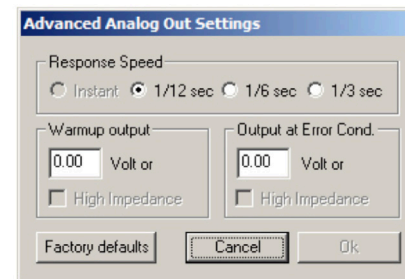

When setting the MTX-OL PLUS to the slower response speed settings, the measured mixture data will be averaged over the response time setting before being sent via the analog output.

4.2.3 Updating the Firmware



Do not update the firmware if the versions are the same. A firmware update should only be necessary if there has been a new release that specifically fixes a problem that you are experiencing with the controller.

1. Connect the MTX-OL PLUS to the computer and launch LM Programmer.
2. Once connected, LM Programmer will display the current version of the firmware that is installed in the MTX-OL PLUS. Do not flash the firmware if the versions are the same.
3. On the 'Info' tab of LM Programmer you will see a button labeled "Update Firmware," click this button.
4. Select the firmware file with the .dld extension. If there have been revisions to the firmware, you will find them available for download from the Support section of the Innovate Motorsports web site.
5. The software will now prompt you to confirm that you wish to overwrite the firmware currently on your MTX-OL PLUS.
6. Click OK, the gauge of the MTX-OL PLUS will go blank. DO NOT power off or disconnect the MTX-OL PLUS from the computer until the firmware progress screen completely disappears. Once finished, you may disconnect the unit from the computer and exit out of the software.

4 Logworks 3 & LM Programmer Software Package

The MTX-OL PLUS can be connected directly to your Windows computer to log and analyze data with the Logworks software or to configure with LM Programmer. The software is a free download on the Innovate Motorsports' support section of the website.

4.1 Download and Install the Logworks 3 Software

1. Open your web browser and go to the following URL: <http://www.innovatemotorsports.com/support.php>
2. The LogWorks 3 software download will be the very first thing on the page under the heading Software, click the link to download the software.
3. Double click on the Logworks 3 installer previously downloaded from the support section of the Innovate Motorsports web site.
4. The installer will start, follow the prompts to install the software.
5. Once the software has been installed, the LogWorks software, LM Programmer, manuals, and tools can then be located by navigating through Start->Programs->LogWorks3.

4.2 LM Programmer

LM Programmer is used to configure settings on your MTX-OL PLUS.

1. Connect the OUT port of the MTX-OL PLUS to the provided serial programming cable. Connect the other end of the serial programming cable to your computer. If your computer does not have a serial port, you can purchase a USB to Serial adapter from Innovate Motorsports (P/N 37330) or use any USB to serial adaptor that includes drivers. Make sure that nothing is connected to the IN port of the MTX-OL PLUS.
2. Disconnect any other MTS devices connected in the serial IN of the MTX-OL PLUS.
3. Power up the MTX-OL PLUS.
4. Launch LM Programmer. The LM Programmer application can be launched from Start->Programs->LogWorks3->LM Programmer from the Windows task bar.

4.2.1 Programming Analog Output

Connect the MTX-OL PLUS to the computer and launch LM Programmer. Select the Analog Output tab. The analog output configuration screen shows voltage versus Lambda for the analog output. The graph display is automatically scaled to the selected voltage values. The configuration screen allows the user to specify a minimum and maximum lambda or A/F value to a corresponding voltage range.

By selecting the 'use Air-Fuel-Ratio' button you can change the displayed unit of measure for mixture by AFR instead of Lambda. This does not change the programming, only the unit of measure displayed in the configuration screen.

Route sensor cable away from sources of heat (such as exhaust/turbo) and RF / EMI such as charging system, fuel pump, and ignition wiring.

- When installed in the exhaust, the oxygen sensor must be connected to a powered, functional MTX-OL PLUS (no error codes) whenever the engine is running. An un-powered sensor will be damaged in a short period of time when exposed to exhaust gas.
- Do not pre-warm the sensor before starting the engine, simply start the engine as normal. Allowing the sensor to pre-warm before starting the engine will increase the possibility of damaging the sensor from shock-cooling.



- Sensor bung should be welded at an angle that places the sensor a minimum of 10 degrees above horizontal (parallel to the ground) to allow for condensation drain and at least 10 degrees from vertical to avoid overheating the sensor. (See diagram)
- Exhaust pipe in front of the sensor should not contain any pockets, projections, protrusions, edges, flex-tubes, etc. in order to avoid accumulation of condensation which can damage the sensor.
- Open and/or leaky exhausts and camshaft overlap are known causes of false lean sensor readings at light to moderate engine loads. Once engine load increases and increased exhaust volume is present reading accuracy improves as fresh air spoiling the readings is expelled from the sensor element.
- Always install the sensor prior to any catalytic converters present on the vehicle's exhaust to ensure proper readings as the catalytic converter will cause readings which are leaner than actual, the amount of variance is affected by engine load and efficiency of the converter.
- Sensor will get very hot during operation – exercise appropriate caution when working near to the sensor to avoid burns and locate accordingly to avoid damage to nearby vehicle components which may be heat sensitive.

There are many contributing factors that affect sensor lifetime, making it impossible to predict longevity for all applications. The O2 sensor is considered a wear item and is not covered by product warranty. These variables include, but are not limited to:

- Contaminants such as lead, oil, coolant, and silicone
- Sensor overheating due to incorrect sensor placement.
- Thermal cycling without exposure to exhaust gas.
- Sensor shock - physical impacts or drops.

Regular free-air calibration will maintain the accuracy over its lifetime and prolong the life of the sensor.

 **As the O2 sensor measures the oxygen content of the exhaust gas to provide an accurate O2 reading, even a small pin-hole leak in a poorly welded sensor bung will effect the accuracy and performance of your O2 sensor. Remember, any deviation from the instructions provided for proper sensor installation will lead to inaccurate O2 readings.**

2.4 Sensor Calibration

Once the unit has been wired and a suitable location has been found for both the gauge and the sensor it is time to do the sensor calibration. Innovate Motorsports' 'Direct Digital' wideband measurement principal allows you to calibrate the sensor to compensate for sensor wear. This procedure takes just a few moments and it will ensure the most accurate readings throughout the oxygen sensor's life. This procedure is required anytime a NEW oxygen sensor is installed.

The calibration procedure requires that the oxygen sensor be in free air, this means removed from the exhaust system completely.

1. With the sensor disconnected, apply power to the MTX-OL PLUS.

When power is applied, all three digits will light up. Then the display will read "E2". This is an error code, indicating that no sensor is detected. Leave unit powered on for minimum 30 seconds.

2. **Power down** the MTX-OL PLUS and attach the oxygen sensor using the cable provided. When making these connections, make sure they are fully seated and locked. Again, make sure that the sensor is in free air (not in the exhaust).
3. **Power up** the MTX-OL PLUS.

Again, the display will have three lines, but instead of an error, the display will display "Htr". This indicates that the sensor is being heated up to operating temperature. After 30-60 seconds, the display will switch from "Htr" to "CAL", indicating that the sensor is being calibrated. A few seconds later, your MTX-OL PLUS will begin displaying AFR. Since the sensor is in free air, the gauge will default to the upper limit of 22.4.

The calibration procedure has completed and the system is now ready for use.

Important: You can disconnect and reconnect the sensor and sensor cable for installation while power is off without losing your calibration. However, if you power up the MTX-OL PLUS without a sensor connected, **your calibration will be reset** (see step #1 above).

2.4.1 Calibration Schedule

Normally aspirated daily driver:

- Calibrate before installation of new sensor
- Calibrate new sensor again after 3 month of use
- Thereafter calibrate once a year or every 20,000 miles, whichever comes first

Turbo car, daily driver (richer mixture):

- Calibrate before installation of new sensor
- Calibrate new sensor again after 3 month of use
- Thereafter calibrate twice a year or every 10,000 miles, whichever comes first.

Race car

- Calibrate before first installation of new sensor
- Calibrate once per race weekend

3 MTX-OL PLUS Configuration

The MTX-OL PLUS can be setup to display AFR or Lambda. When configured to display AFR, it can be setup for any fuel type setting. The configuration can be done by connecting the unit to the LM Programmer software.

3.1 Configuration using the LM Programmer software

Refer to chapter 4, Logworks 3 & LM Programmer Software Package to gain access to the software.

1. Power the MTX-OL PLUS OFF.
2. Disconnect any devices connected to the serial IN port
3. Connect the OUT port of the MTX-OL PLUS to the provided serial programming cable. Connect the other end of the serial programming cable to your computer. If your computer does not have a serial port, you can purchase a USB to Serial adapter from Innovate Motorsports (P/N 37330) or use any USB to serial adaptor that includes drivers. Make sure that nothing is connected to the IN port of the MTX-OL PLUS.
4. Power up the MTX-OL PLUS.
5. Launch **LM Programmer**. The LM Programmer application can be launched from Start->Programs->LogWorks3->LM Programmer from the Windows task bar.

Once you have completed your desired changes, press the **Program** button on the lower right on the software application. You will know that the MTX-OL PLUS has been programmed successfully when the **Program** button grays out.

3.2 Display Settings (Gauge Abbreviations)

1. **Wideband O2 Units (WB O2 Units)** – Allows the gauge to display O2 units in either AFR or Lambda. Default setting is AFR.
Note: In LM Programmer you can also setup the display to show percentage of Oxygen. Once the measurements are leaner than 7 lambda unit will automatically switch to percentage of O2
2. **Fuel Type** – Change to different fuel types when MTX-OL PLUS is setup to display in AFR. Default setting is Gasoline.